

▶ **inductive high temperature sensors  
up to +180°C**

**flush, non-flush, all-metal**

---

**NOTES**

A large grid area for taking notes, consisting of a 20x30 grid of small squares. The grid is empty and occupies the majority of the page below the 'NOTES' header.

dimensions

- M8 x 1
- M12 x 1mm
- M18 x 1mm
- M30 x 1.5mm
- M50 x 1.5mm
- M80 x 1.5mm
- 8 x 40 x 8mm
- 12 x 55 x 12mm
- 12 x 66 x 12mm
- 40 x 40mm

flush	switching distance	<b>2 to 10mm</b>
non-flush	switching distance	<b>4 to 50mm</b>

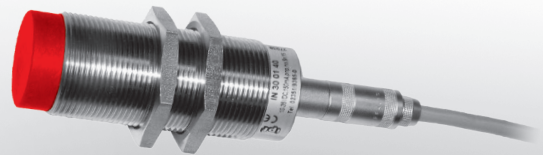

- ✓ an innovation of ipf electronic
- ✓ all-metal sensors all around (sleeve, front- and backside) made of stainless steel
- ✓ with integrated amplifier
- ✓ connection via cable, M12 or Lemo-connector

**active surface made of stainless steel or Vectra® devices usable up to +180°C**

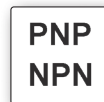
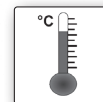

**description**

Inductive high temperature sensors are available with integrated amplifiers in the M8, M12, M18, M30, M50, M80 and cuboid designs. The maximum ambient temperature, depending on the version, can lie between +130°C and +180°C. The devices are available with silicone or teflon cables and also with M12 or Lemo-connectors.

On the active surfaces, devices with full metal housings are absolutely impermeable to fluids and gases, against which the entire housing material is resistant.

They are much more resistant to mechanical loads than conventional proximity switches. Easy cleaning with a stream jet is also satisfied.

To obtain the maximum switching distance, pay attention to the size of the object (standard target) and its surface finish (even surface).

**application examples**

- ▶ integration in machine parts subject to rough industrial environments
- ▶ robotics applications in welding plants
- ▶ detection of hot workpieces in the steel industry, in foundries and glass manufacture
- ▶ positioning hot parts in handling and conveying systems
- ▶ foodstuffs industry, chemical industry

**Notes on inductive proximity switches**

- I      inductive sensor
- IB     flush
- IC     flush, all-metal
- IN     non-flush

**functional principle**

The oscillation coil behind the active surface of the proximity switch produces an alternating electromagnetic field. Any electrically conductive material entering the field will induce rotational currents extracting energy from the oscillating circuit. The damping of the oscillator is then converted into a switching signal in the output amplifier.

It follows the functional principle that all metals are detected, moving or not. Important: The high frequency field produces no measurable increase in temperature and no magnetic influence inside the object to be detected. That means the sensors operate without interacting with the system.

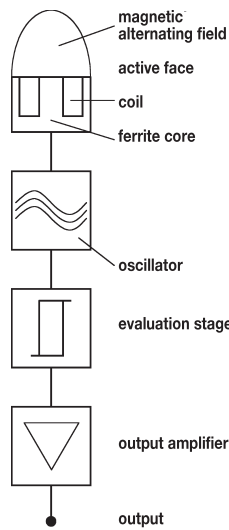

functional principle of an inductive proximity switch

**switching distance / norm measuring plate**

The distance to the sensor surface, where a metal causes a change in the switching state, is called switching distance. This distance is not the same for all metals. That is why a so-called correction factor has been specified for the respective metal, e.g. copper or aluminum. The nominal switching distance is determined by a norm measuring plate. This is a quadratic metal plate made from steel (St37) with a thickness of 1mm and a smoothed surface for determining the switching distance  $S_n$ , otherwise the edge length is the same as the diameter of the active surface.

One differentiates between the normal switching distance  $S_n$ , which is determined without consideration for manufacturing tolerances or external influences, and the operational switching distance  $S_a$ .

The safe operational switching distance is between 0 and 81% of  $S_n$  ( $0 < S_a < 0.81 \times S_n$ ).

**switching hysteresis**

During the approach and subsequent removal of the measuring plate from the initiator there will be a difference between switch-on point and switch-off point. This integrated hysteresis prevents the switching output from oscillating during mechanical vibrations. Usually the hysteresis is between 3 to 15% of  $S_n$ .

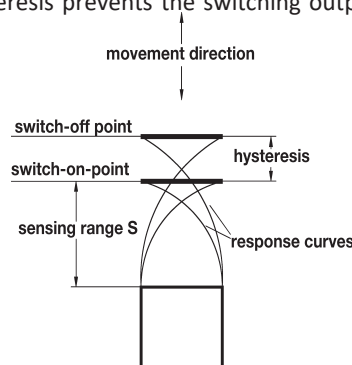

**output circuit**

For the switching outputs of DC devices, a differentiation is made between PNP and NPN. For PNP outputs the load is connected in such a way that it is energized (positive switching) when the sensor is driven to full output (damping). NPN devices maintain their load permanently energized, switching the earth connection only (negative switching). A corresponding wiring diagram is supplied with every sensor.

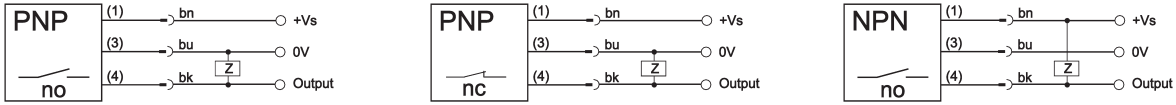

**series connection**

When a number of sensors are connected in series, the voltage drop of each device should be taken into account in order to ensure that even the final device also receives the required operating voltage. The internal electronics permits a maximum of 3 devices to be connected in series.

To be operationally safe the connection in series of 3-wire PNP sensors requires a logical AND-gate, e.g. VL250100.

**parallel connection**

When connecting 3-wire PNP-sensors in parallel, the internal resistance of the sensor that is driven to full output influences the other proximity switches. This requires decoupling diodes to be inserted into the outputs. A logical OR-gate, e.g. the VL250120, can be used to facilitate the connection in parallel.

**mounting**

Please follow the mounting instructions for flush or non-flush sensors when installing inductive proximity switches into a metal backing material to avoid undefined switching of the device. For a flush device the active face may be on one level with the backing material.

Non-flush sensors must protrude. As a rule of thumb use 2x the nominal switching distance of the sensor.

mounting instructions for flush sensors

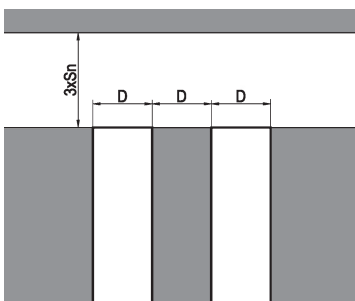

mounting instructions for non-flush sensors

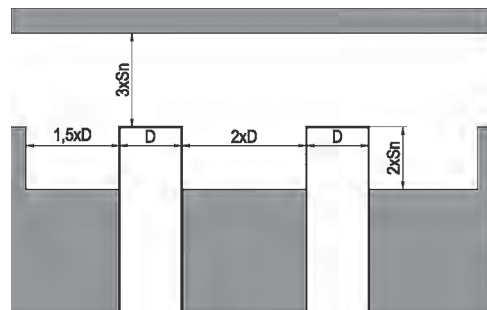

**switching frequency**

The switching frequency states the maximum number of available switching operations per second. Every switching operation of the inductive proximity switch causes the oscillating circuit to move.

The time needed for the oscillation puts a limit on the switching frequency.

For half the nominal switching distance the pulse to pause ratio should be at least 1 : 2,

i.e. when choosing the right proximity switch, a compromise needs to be made between the size of the sensor and the switching frequency. General rule: The larger the sensor, the lower the switching frequency.

### tightening torques

To avoid damage when mounting proximity switches, never exceed the tightening torque given.

### metal threads

M8	=	3Nm
M12	=	20Nm
M18	=	50Nm
M30	=	150Nm
M50	=	200Nm
M80	=	200Nm

### active switching zone / active surface:

The active switching zone is the area in front of the active surface, within which the proximity switch reacts to the approach of metal parts, i.e. changes the state of the output.

### nominal switching distance ( $S_n$ ):

The distance at which a metal part that is approaching the active surface of the proximity switch causes a status change in the state of the switching output.

### repeatability:

Repeat accuracy of two measurements under standardized conditions. The difference in the measured values should be less than 10%.

### output function:

normally open: Object within the area of the active switching zone – output switched

normally closed: Object within the area of the active switching zone – output inhibited

### readiness delay:

Time required by the proximity switch to be functional after the supply voltage is applied (lies in the millisecond range).

### correction factors:

Specify the reduction in the switching distance, if materials other than steel St37 are used. The change in the switching distance depends on the type, characteristics (internal structure), size and the geometry of the material that is to be detected.

typical correction factors: St: 1    V2A: approx. 0.7    Ms: approx. 0.4    Al: approx. 0.3    Cu: approx. 0.2

In order to assess the approximate switching distance on the materials which differ from St37, the switching distance for St37 has to be multiplied by the appropriate correction factor.

### repeat accuracy:

The repeat accuracy (according to IEC 60947-5-2 / EN 60947-5-2) is the repeat accuracy of the real switching distance  $S_r$  over a period of 8 hours at an ambient temperature of  $(23 \pm 5)^\circ\text{C}$  and a defined operating voltage. The specified repeat accuracy corresponds to this definition. Generally the repeat accuracy is considerably better in case of sequent measurements.

### reverse polarity protection:

An internal protection prevents destruction of the proximity switch if the connection lines are accidentally swapped.

### short-circuit protection:

An internal protection prevents destruction of the proximity switch in case of an overcurrent.

### switching point drift:

The switching point shifts due to the change e.g. in ambient temperature.

**Warning:** Never use these devices in applications where the safety of a person depends on their functionality.

switching distance	2mm	2mm	2mm	3mm
operating temperature	0 ... +140°C	0 ... +140°C	0 ... +140°C	0 ... +130°C
output signal	pnp, no	pnp, nc	pnp, no	pnp, no
mounting	flush	flush	flush	flush
2m silicone cable	IB080150	IB080250	-	IB120155
5m silicone cable	IB080151	IB080251	-	IB120156
10m silicone cable	IB080152	IB080252	-	IB120157
2m teflon cable	IB0801T0	-	-	-
5m teflon cable	IB0801T1	-	-	-
10m teflon cable	IB0801T2	-	-	-
M12 cable connector	-	-	IB08012W	-

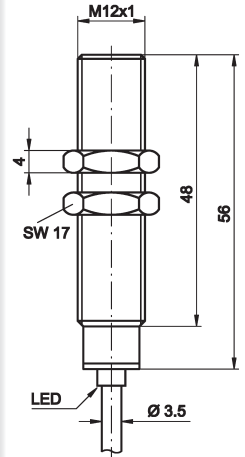
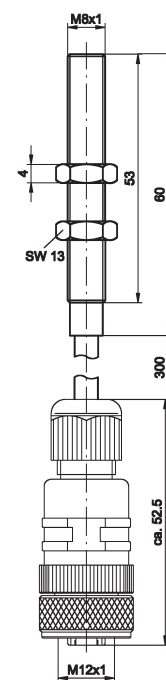
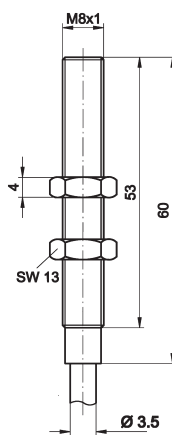
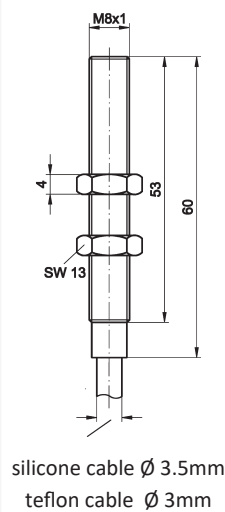

**TECHNICAL DATA**

switching distance	2mm	2mm	2mm	3mm
output signal	pnp, no	pnp, nc	pnp, no	pnp, no
operating voltage	10 ... 30V DC	10 ... 30V DC	10 ... 35V DC	10 ... 35V DC
current consumption (w/o load)	≤ 15mA	≤ 15mA	≤ 15mA	≤ 15mA
output current (max. load)	50mA	50mA	80mA	120mA
voltage drop (max. load)	2.0V DC	2.0V DC	2.0V DC	2.0V DC
hysteresis	3 ... 15%	3 ... 15%	3 ... 15%	3 ... 15%
switching frequency	600Hz	600Hz	600Hz	500Hz
display (signal)	-	-	-	yellow LED
short-circuit protection	+	+	+	+
reverse polarity protection	+	+	+	+
dimensions	M8x1	M8x1	M8x1	M12x1
housing material	stainl. steel	stainl. steel	stainl. steel	stainl. steel
material (front cap)	Vectra®	Vectra®	Vectra®	Vectra®
length (thread/complete)	53mm / 60mm	53mm / 60mm	53mm / 60mm	48mm / 56mm
operating temperature	0 ... +140°C	0 ... +140°C	0 ... +140°C	0 ... +130°C
degree of protection (EN 60529)	IP65	IP65	IP65	IP65
connection	see above	see above	M12 cable connector	see above
connection accessories	-	-	e.g. VK50H026	-
mounting accessories (clip)	AY000098	AY000098	AY000099	AY000099

switching distance	3mm	3mm	3mm	3mm
operating temperature	0 ... +150°C	0 ... +150°C	0 ... +150°C	0 ... +150°C
output signal	pnp, no	pnp, nc	pnp, no	pnp, no
mounting	flush	flush	flush	flush
2m silicone cable	IB120150	IB120250	-	-
5m silicone cable	IB120151	-	-	-
10m silicone cable	IB120152	-	-	-
2m teflon cable	IB1201T0	-	-	-
5m teflon cable	IB1201T1	-	-	-
10m teflon cable	IB1201T2	-	-	-
M12-connector	-	-	-	IB12012W
Lemo mini-connector	-	-	IB1201L0	-

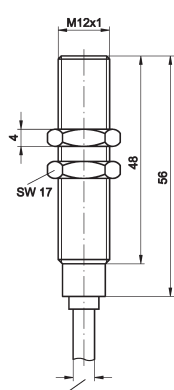

silicone cable  $\varnothing$  5mm  
teflon cable  $\varnothing$  3mm

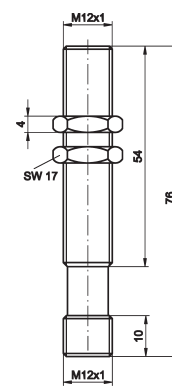
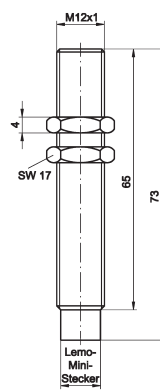
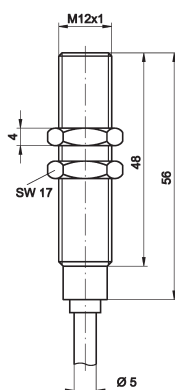

### TECHNICAL DATA

switching distance	3mm	3mm	3mm	3mm
output signal	pnp, no	pnp, nc	pnp, no	pnp, no
operating voltage	10 ... 35V DC	10 ... 35V DC	10 ... 35V DC	10 ... 35V DC
current consumption (w/o load)	$\leq$ 15mA	$\leq$ 15mA	$\leq$ 15mA	$\leq$ 15mA
output current (max. load)	120mA	120mA	120mA	120mA
voltage drop (max. load)	2.0V DC	2.0V DC	2.0V DC	2.0V DC
hysteresis	3 ... 15%	3 ... 15%	3 ... 15%	3 ... 15%
switching frequency	500Hz	500Hz	500Hz	500Hz
display (signal)	-	-	-	-
short-circuit protection	+	+	+	+
reverse polarity protection	+	+	+	+
dimensions	M12x1	M12x1	M12x1	M12x1
housing material	stainl. steel	stainl. steel	stainl. steel	stainl. steel
material (front cap)	Vectra®	Vectra®	Vectra®	Vectra®
length (thread/complete)	48mm / 56mm	48mm / 56mm	65mm / 73mm	54mm / 76mm
operating temperature	0 ... +150°C	0 ... +150°C	0 ... +150°C	0 ... +150°C
degree of protection (EN 60529)	IP65	IP65	IP50	IP65
connection	see above	2m silicone cable	Lemo mini-connector	M12-connector
connection accessories	-	-	e.g. VK2000L4	e.g. VK50H026
mounting accessories	AY000099	AY000099	AY000099	AY000099

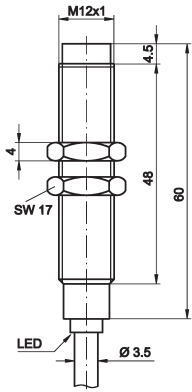
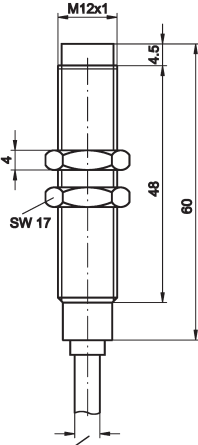
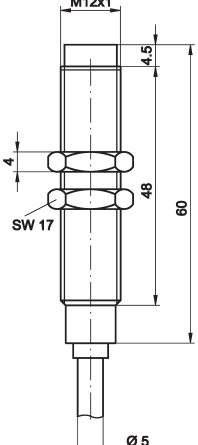
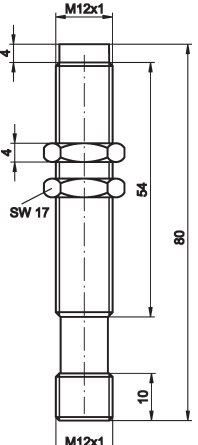

switching distance	4mm	4mm	4mm	4mm
operating temperature	0 ... +130°C	0 ... +150°C	0 ... +150°C	0 ... +150°C
output signal	pnp, no	pnp, no	pnp, nc	pnp, no
mounting	non-flush	non-flush	non-flush	non-flush
2m silicone cable	IN120155	IN120150	IN120250	-
5m silicone cable	IN120156	IN120151	-	-
10m silicone cable	IN120157	IN150152	-	-
2m teflon cable	-	IN1201T0	-	-
5m teflon cable	-	IN1201T1	-	-
10m teflon cable	-	IN1201T2	-	-
M12-connector	-	-	-	IN12012W
		 silicone cable Ø 5mm teflon cable Ø 3mm		
<b>TECHNICAL DATA</b>				
switching distance	4mm	4mm	4mm	4mm
output signal	pnp, no	pnp, no	pnp, nc	pnp, no
operating voltage	10 ... 35V DC	10 ... 35V DC	10 ... 35V DC	10 ... 35V DC
current consumption (w/o load)	≤ 15mA	≤ 15mA	≤ 15mA	≤ 15mA
output current (max. load)	120mA	120mA	120mA	120mA
voltage drop (max. load)	2.0V DC	2.0V DC	2.0V DC	2.0V DC
hysteresis	3 ... 15%	3 ... 15%	3 ... 15%	3 ... 15%
switching frequency	500Hz	500Hz	500Hz	500Hz
display (signal)	yellow LED	-	-	-
short-circuit protection	+	+	+	+
reverse polarity protection	+	+	+	+
dimensions	M12x1	M12x1	M12x1	M12x1
housing material	stainl. steel	stainl. steel	stainl. steel	stainl. steel
material (front cap)	Vectra®	Vectra®	Vectra®	Vectra®
length (thread/complete)	48mm / 60mm	48mm / 60mm	48mm / 60mm	54mm / 80mm
operating temperature	0 ... +130°C	0 ... +150°C	0 ... +150°C	0 ... +150°C
degree of protection (EN 60529)	IP65	IP65	IP65	IP65
connection	see above	see above	2m silicone cable	M12-connector
connection accessories	-	-	-	e.g. VK50H026
mounting accessories	AY000099	AY000099	AY000099	AY000099

switching distance	5mm	5mm	5mm	5mm
operating temperature	0 ... +130°C	0 ... +180°C	0 ... +180°C	0 ... +180°C
output signal	pnp, no	pnp, no	pnp, nc	nnp, no
mounting	flush	flush	flush	flush
2m silicone cable	IB180155	IB180150	IB180250	IB181150
5m silicone cable	IB180156	IB180151	IB180251	
10m silicone cable	IB180157	IB180152	IB180252	IB181152
2m teflon cable	-	IB1801T0	-	-
5m teflon cable	-	IB1801T1	IB1802T1	-
10m teflon cable	-	IB1801T2	-	-

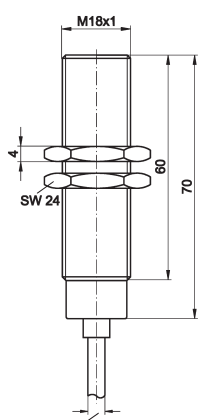
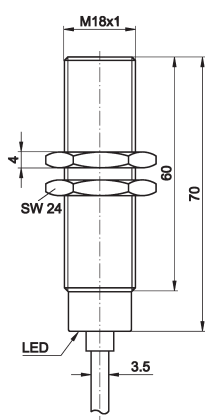

silicone cable Ø 5mm  
teflon cable Ø 3mm

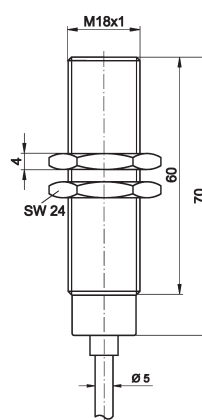

silicone cable Ø 5mm  
teflon cable Ø 3mm

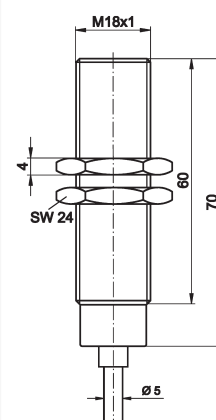

### TECHNICAL DATA

switching distance	5mm	5mm	5mm	5mm
output signal	pnp, no	pnp, no	pnp, nc	nnp, no
operating voltage	10 ... 35V DC	10 ... 35V DC	10 ... 35V DC	10 ... 35V DC
current consumption (w/o load)	≤ 15mA	≤ 15mA	≤ 15mA	≤ 15mA
output current (max. load)	120mA	150mA	150mA	150mA
voltage drop (max. load)	2.0V DC	2.0V DC	2.0V DC	2.0V DC
hysteresis	3 ... 15%	3 ... 15%	3 ... 15%	3 ... 15%
switching frequency	400Hz	400Hz	400Hz	400Hz
display (signal)	yellow LED	-	-	-
short-circuit protection	+	+	+	+
reverse polarity protection	+	+	+	+
dimensions	M12x1	M18x1	M18x1	M18x1
housing material	stainl. steel	stainl. steel	stainl. steel	stainl. steel
material (front cap)	Vectra®	Vectra®	Vectra®	Vectra®
length (thread/complete)	60mm / 70mm	60mm / 70mm	60mm / 70mm	60mm / 70mm
operating temperature	0 ... +130°C	0 ... +180°C	0 ... +180°C	0 ... +180°C
degree of protection (EN 60529)	IP65	IP65	IP65	IP65
connection	see above	see above	see above	see above
connection accessories	-	-	-	-
mounting accessories	AY000100	AY000100	AY000100	AY000100

switching distance	5mm	5mm	5mm	8mm
operating temperature	0 ... +180°C	0 ... +180°C	0 ... +150°C	0 ... +130°C
output signal	pnp, no	pnp, nc	pnp, no	pnp, no
mounting	flush	flush	flush	non-flush
2m silicone cable	-	-	-	IN180155
5m silicone cable	-	-	-	IN180156
10m silicone cable	-	-	-	IN180157
M12-connector	-	-	IB18012W	-
Lemo connector	IB180140	IB180240	-	-

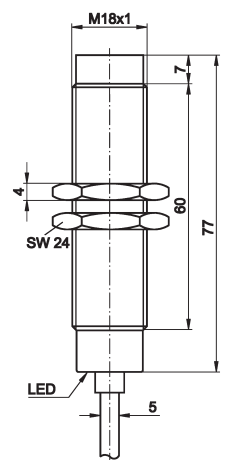
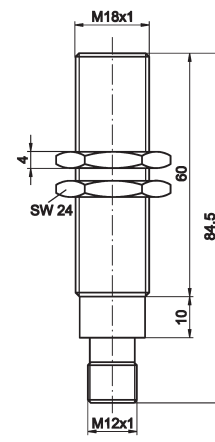
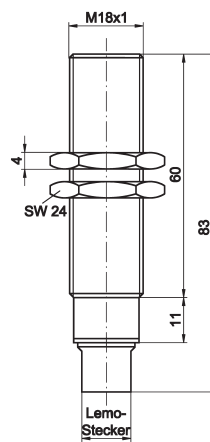
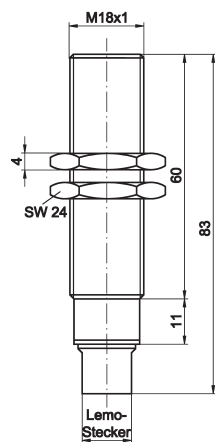

**TECHNICAL DATA**

switching distance	5mm	5mm	5mm	8mm
output signal	pnp, no	pnp, nc	pnp, no	pnp, no
operating voltage	10 ... 35V DC	10 ... 35V DC	10 ... 35V DC	10 ... 35V DC
current consumption (w/o load)	≤ 15mA	≤ 15mA	≤ 15mA	≤ 15mA
output current (max. load)	150mA	150mA	150mA	150mA
voltage drop (max. load)	2.0V DC	2.0V DC	2.0V DC	2.0V DC
hysteresis	3 ... 15%	3 ... 15%	3 ... 15%	3 ... 15%
switching frequency	400Hz	400Hz	400Hz	400Hz
display (signal)	-	-	-	yellow LED
short-circuit protection	+	+	+	+
reverse polarity protection	+	+	+	+
dimensions	M18x1	M18x1	M18x1	M18x1
housing material	stainl. steel	stainl. steel	stainl. steel	stainl. steel
material (front cap)	Vectra®	Vectra®	Vectra®	Vectra®
length (thread/complete)	60mm / 83mm	60mm / 83mm	60mm / 84.5mm	60mm / 77mm
operating temperature	0 ... +180°C	0 ... +180°C	0 ... +150°C	0 ... +130°C
degree of protection (EN 60529)	IP50	IP50	IP65	IP65
connection	Lemo-connector	Lemo-connector	M12-connector	see above
connection accessories	e.g. VK200940	e.g. VK200940	e.g. VK50H026	-
mounting accessories	AY000100	AY000100	AY000100	AY000100

switching distance	8mm	8mm	8mm	8mm
operating temperature	0 ... +180°C	0 ... +180°C	0 ... +180°C	0 ... +150°C
output signal	pnp, no	pnp, nc	npn, no	pnp, no
mounting	non-flush	non-flush	non-flush	non-flush
2m silicone cable	IN180150	IN180250	IN181150	-
5m silicone cable	IN180151	-	IN181151	-
10m silicone cable	IN180152	-	IN181152	-
2m teflon cable	IN1801T0	IN1802T0	-	-
5m teflon cable	IN1801T1	-	-	-
10m teflon cable	IN1801T2	-	-	-
M12-connector	-	-	-	IN18012W

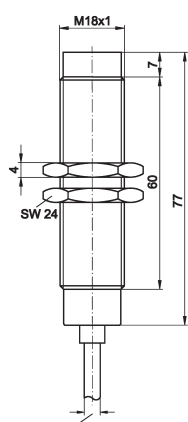

silicone cable  $\varnothing$  5mm  
teflon cable  $\varnothing$  3mm

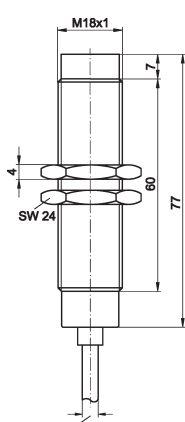

silicone cable  $\varnothing$  5mm  
teflon cable  $\varnothing$  3mm

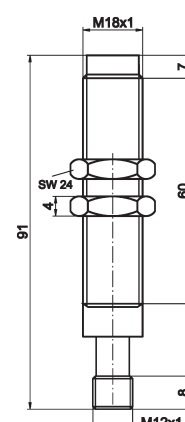
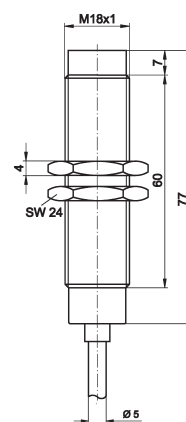

### TECHNICAL DATA

switching distance	8mm	8mm	8mm	8mm
output signal	pnp, no	pnp, nc	npn, no	pnp, no
operating voltage	10 ... 35V DC	10 ... 35V DC	10 ... 35V DC	10 ... 35V DC
current consumption (w/o load)	$\leq$ 15mA	$\leq$ 15mA	$\leq$ 15mA	$\leq$ 15mA
output current (max. load)	150mA	150mA	150mA	150mA
voltage drop (max. load)	2.0V DC	2.0V DC	2.0V DC	2.0V DC
hysteresis	3 ... 15%	3 ... 15%	3 ... 15%	3 ... 15%
switching frequency	400Hz	400Hz	400Hz	400Hz
display (signal)	-	-	-	-
short-circuit protection	+	+	+	+
reverse polarity protection	+	+	+	+
dimensions	M18x1	M18x1	M18x1	M18x1
housing material	stainl. steel	stainl. steel	stainl. steel	stainl. steel
material (front cap)	Vectra®	Vectra®	Vectra®	Vectra®
length (thread/complete)	60mm / 77mm	60mm / 77mm	60mm / 77mm	60mm / 91mm
operating temperature	0 ... +180°C	0 ... +180°C	0 ... +180°C	0 ... +150°C
degree of protection (EN 60529)	IP65	IP65	IP65	IP65
connection	see above	see above	see above	M12-connector
connection accessories	-	-	-	e.g. VK50H026
mounting accessories	AY000100	AY000100	AY000100	AY000100

switching distance	10mm	10mm	10mm	10mm
operating temperature	0 ... +130°C	0 ... +130°C	0 ... +150°C	0 ... +150°C
output signal	pnp, no	pnp, no	pnp, no	pnp, nc
mounting	flush	flush	flush	flush
2m silicone cable	IB300155	-	-	-
5m silicone cable	IB300156	-	-	-
10m silicone cable	IB300157	-	-	-
M12-connector	-	-	IB30012W	IB30022W
Lemo connector	-	IB300145	-	-

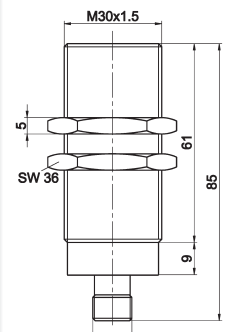
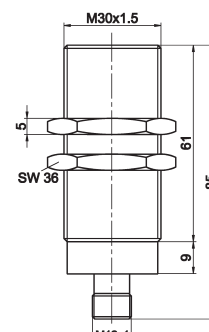
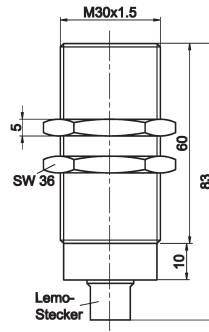
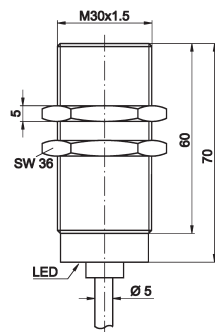

**TECHNICAL DATA**

switching distance	10mm	10mm	10mm	10mm
output signal	pnp, no	pnp, no	pnp, no	pnp, nc
operating voltage	10 ... 35V DC	10 ... 35V DC	10 ... 35V DC	10 ... 35V DC
current consumption (w/o load)	≤ 15mA	≤ 15mA	≤ 15mA	≤ 15mA
output current (max. load)	150mA	150mA	150mA	150mA
voltage drop (max. load)	2.0V DC	2.0V DC	2.0V DC	2.0V DC
hysteresis	3 ... 15%	3 ... 15%	3 ... 15%	3 ... 15%
switching frequency	200Hz	200Hz	200Hz	200Hz
display (signal)	yellow LED	-	-	-
short-circuit protection	+	+	+	+
reverse polarity protection	+	+	+	+
dimensions	M30x1.5	M30x1.5	M30x1.5	M30x1.5
housing material	stainl. steel	stainl. steel	stainl. steel	stainl. steel
material (front cap)	Vectra®	Vectra®	Vectra®	Vectra®
length (thread/complete)	60mm / 70mm	60mm / 83mm	61mm / 85mm	61mm / 85mm
operating temperature	0 ... +130°C	0 ... +130°C	0 ... +150°C	0 ... +150°C
degree of protection (EN 60529)	IP65	IP50	IP65	IP65
connection	see above	Lemo-connector	M12-connector	M12-connector
connection accessories	-	e.g. VK200940	e.g. VK50H026	e.g. VK50H026
mounting accessories	AY000101/AY000104	AY000101/AY000104	AY000101/AY000104	AY000101/AY000104

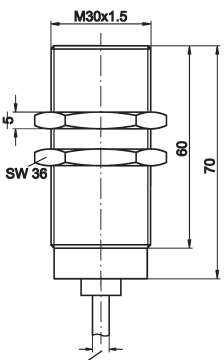
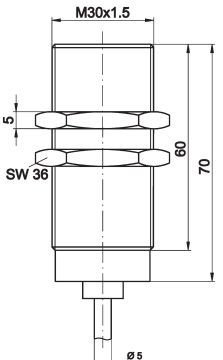
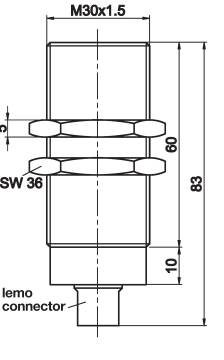
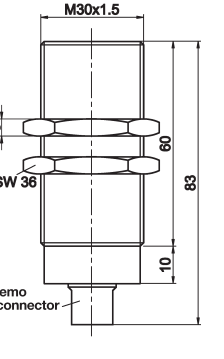
switching distance	10mm	10mm	10mm	10mm
operating temperature	0 ... +180°C	0 ... +180°C	0 ... +180°C	0 ... +180°C
output signal	pnp, no	pnp, nc	pnp, no	pnp, nc
mounting	flush	flush	flush	flush
2m silicone cable	IB300150	IB300250	-	-
5m silicone cable	IB300151	-	-	-
10m silicone cable	IB300152	-	-	-
2m teflon cable	IB3001T0	-	-	-
5m teflon cable	IB3001T1	-	-	-
10m teflon cable	IB3001T2	-	-	-
Lemo-connector	-	-	IB300140	IB300240
	 <p>silicone cable Ø 5mm teflon cable Ø 3mm</p>			
<b>TECHNICAL DATA</b>				
switching distance	10mm	10mm	10mm	10mm
output signal	pnp, no	pnp, nc	pnp, no	pnp, nc
operating voltage	10 ... 35V DC	10 ... 35V DC	10 ... 35V DC	10 ... 35V DC
current consumption (w/o load)	≤ 15mA	≤ 15mA	≤ 15mA	≤ 15mA
output current (max. load)	150mA	150mA	150mA	150mA
voltage drop (max. load)	2.0V DC	2.0V DC	2.0V DC	2.0V DC
hysteresis	3 ... 15%	3 ... 15%	3 ... 15%	3 ... 15%
switching frequency	200Hz	200Hz	200Hz	200Hz
display (signal)	-	-	-	-
short-circuit protection	+	+	+	+
reverse polarity protection	+	+	+	+
dimensions	M30x1.5	M30x1.5	M30x1.5	M30x1.5
housing material	stainl. steel	stainl. steel	stainl. steel	stainl. steel
material (front cap)	Vectra®	Vectra®	Vectra®	Vectra®
length (thread/complete)	60mm / 70mm	60mm / 70mm	60mm / 83mm	60mm / 83mm
operating temperature	0 ... +180°C	0 ... +180°C	0 ... +180°C	0 ... +180°C
degree of protection (EN 60529)	IP65	IP65	IP50	IP50
connection	see above	see above	see above	see above
connection accessories	-	-	e.g. VK200940	e.g. VK200940
mounting accessories	AY000101/AY000104	AY000101/AY000104	AY000101/AY000104	AY000101/AY000104

switching distance	15mm	15mm	15mm	15mm
operating temperature	0 ... +130°C	0 ... +130°C	0 ... +150°C	0 ... +180°C
output signal	pnp, no	pnp, no	pnp, no	pnp, no
mounting	non-flush	non-flush	non-flush	non-flush
2m silicone cable	IN300155	-	-	IN300150
5m silicone cable	IN300156	-	-	IN300151
10m silicone cable	IN300157	-	-	IN300152
2m teflon cable	-	-	-	IN3001T0
5m teflon cable	-	-	-	IN3001T1
10m teflon cable	-	-	-	IN3001T2
M12-connector	-	-	IN30012W	-
Lemo-connector	-	IN300145	-	-

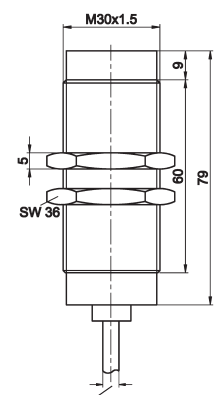
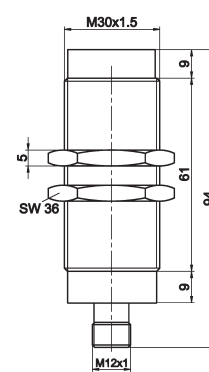
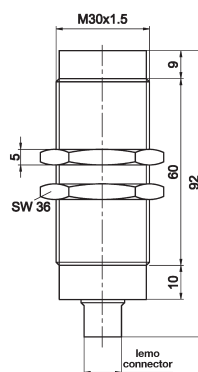
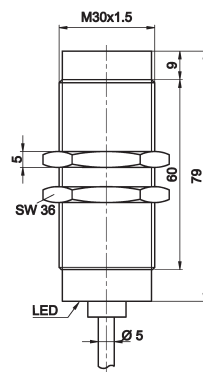

silicone cable Ø 5mm  
teflon cable Ø 3mm

**TECHNICAL DATA**

switching distance	15mm	15mm	15mm	15mm
output signal	pnp, no	pnp, no	pnp, no	pnp, no
operating voltage	10 ... 35V DC	10 ... 35V DC	10 ... 35V DC	10 ... 35V DC
current consumption (w/o load)	≤ 15mA	≤ 15mA	≤ 15mA	≤ 15mA
output current (max. load)	150mA	150mA	150mA	150mA
voltage drop (max. load)	2.0V DC	2.0V DC	2.0V DC	2.0V DC
hysteresis	3 ... 15%	3 ... 15%	3 ... 15%	3 ... 15%
switching frequency	200Hz	200Hz	200Hz	200Hz
display (signal)	yellow LED	-	-	-
short-circuit protection	+	+	+	+
reverse polarity protection	+	+	+	+
dimensions	M30x1.5	M30x1.5	M30x1.5	M30x1.5
housing material	stainl. steel	stainl. steel	stainl. steel	stainl. steel
material (front cap)	Vectra®	Vectra®	Vectra®	Vectra®
length (thread/complete)	60mm / 79mm	60mm / 92mm	61mm / 94mm	60mm / 79mm
operating temperature	0 ... +130°C	0 ... +130°C	0 ... +150°C	0 ... +180°C
degree of protection (EN 60529)	IP65	IP50	IP65	IP65
connection	see above	Lemo-connector	M12-connector	see above
connection accessories	-	e.g. VK200940	e.g. VK50H026	-
mounting accessories	AY000101/AY000104	AY000101/AY000104	AY000101/AY000104	AY000101/AY000104

switching distance	15mm	8mm	15mm
operating temperature	0 ... +180°C	0 ... +140°C	0 ... +140°C
output signal	pnp, no	pnp, no	pnp, no
mounting	non-flush	flush	non-flush
5m stainl. steel teflon cable	-	IB3001S1	-
10m stainl. steel teflon cable	-	IB3001S2	-
15m stainl. steel teflon cable	-	IB3001S3	IN3001S3
Lemo connector	IN300140	-	-

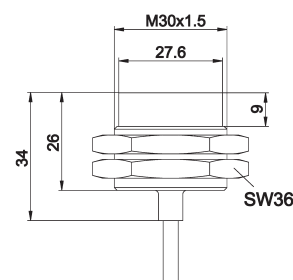
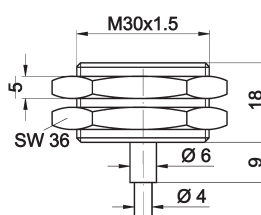
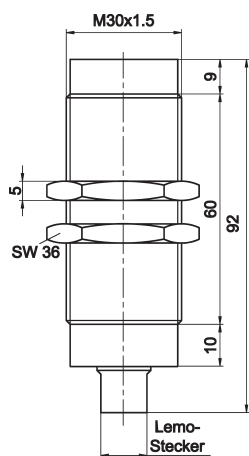

### TECHNICAL DATA

switching distance	15mm	8mm	15mm
output signal	pnp, no	pnp, no	pnp, no
operating voltage	10 ... 35V DC	10 ... 35V DC	10 ... 35V DC
current consumption (w/o load)	≤ 15mA	≤ 15mA	≤ 15mA
output current (max. load)	150mA	150mA	150mA
voltage drop (max. load)	2.0V DC	2.0V DC	2.0V DC
hysteresis	3 ... 15%	3 ... 15%	3 ... 15%
switching frequency	200Hz	200Hz	200Hz
display (signal)	-	-	-
short-circuit protection	+	+	+
reverse polarity protection	+	+	+
dimensions	M30x1.5	M30x1.5	M30x1.5
housing material	stainl. steel	stainl. steel	stainl. steel
material (front cap)	Vectra®	Vectra®	Vectra®
length (thread/complete)	60mm / 92mm	18mm / 18mm	18mm / 27mm
operating temperature	0 ... +180°C	0 ... +140°C	0 ... +140°C
degree of protection (EN 60529)	IP50	IP65	IP65
connection	Lemo-connector	see above	see above
connection accessories	e.g. VK200940	-	-
mounting accessories	AY000101/AY000104	AY000101/AY000104	AY000101/AY000104

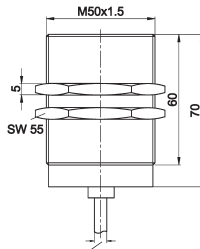
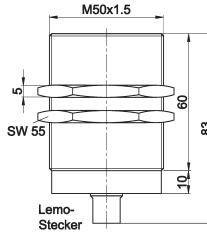
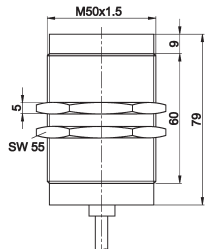
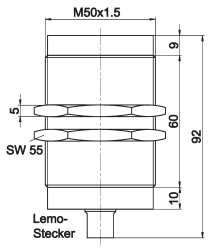

switching distance	20mm	20mm	25mm	25mm
operating temperature	0 ... +180°C	0 ... +180°C	0 ... +180°C	0 ... +180°C
output signal	pnp, no	pnp, no	pnp, no	pnp, no
mounting	flush	flush	non-flush	non-flush
2m silicone cable	IB500150	-	IN500150	-
5m silicone cable	IB500151	-	IN500151	-
10m silicone cable	IB500152	-	IN500152	-
2m teflon cable	IB5001T0	-	IN5001T0	-
5m teflon cable	IB5001T1	-	IN5001T1	-
10m teflon cable	IB5001T2	-	IN5001T2	-
Lemo connector	-	IB500140	-	IN500140
	 <p>silicone cable Ø 5mm teflon cable Ø 3mm</p>		 <p>silicone cable Ø 5mm teflon cable Ø 3mm</p>	
<b>TECHNICAL DATA</b>				
switching distance	20mm	20mm	25mm	25mm
output signal	pnp, no	pnp, no	pnp, no	pnp, no
operating voltage	10 ... 35V DC	10 ... 35V DC	10 ... 35V DC	10 ... 35V DC
current consumption (w/o load)	≤ 15mA	≤ 15mA	≤ 15mA	≤ 15mA
output current (max. load)	150mA	150mA	150mA	150mA
voltage drop (max. load)	2.0V DC	2.0V DC	2.0V DC	2.0V DC
hysteresis	3 ... 15%	3 ... 15%	3 ... 15%	3 ... 15%
switching frequency	100Hz	100Hz	100Hz	100Hz
display (signal)	-	-	-	-
short-circuit protection	+	+	+	+
reverse polarity protection	+	+	+	+
dimensions	M30x1.5	M30x1.5	M30x1.5	M30x1.5
housing material	stainl. steel	stainl. steel	stainl. steel	stainl. steel
material (front cap)	Vectra®	Vectra®	Vectra®	Vectra®
length (thread/complete)	60mm / 70mm	60mm / 83mm	60mm / 79mm	60mm / 92mm
operating temperature	0 ... +180°C	0 ... +180°C	0 ... +180°C	0 ... +180°C
degree of protection (EN 60529)	IP65	IP50	IP65	IP50
connection	see above	Lemo-connector	see above	Lemo-connector
connection accessories	-	e.g. VK200940	-	e.g. VK200940
mounting accessories	AY000101/AY000104	AY000101/AY000104	AY000101/AY000104	AY000101/AY000104

switching distance	50mm	50mm
operating temperature	0 ... +160°C	0 ... +160°C
output signal	pnp, no	pnp, no
mounting	non-flush	non-flush
2m silicone cable	IN800150	-
5m silicone cable	IN800151	-
10m silicone cable	IN800152	-
Lemo connector	-	IN800140

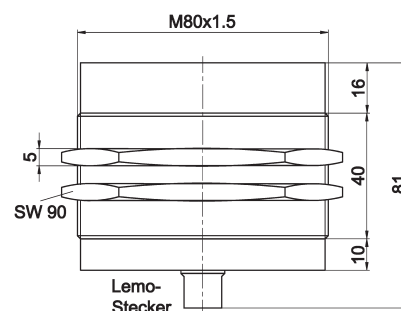
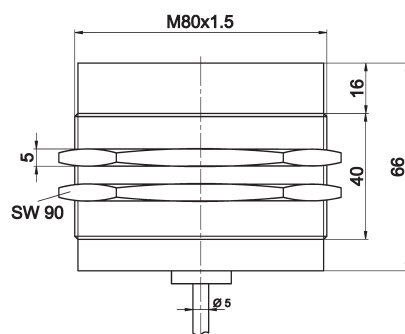

### TECHNICAL DATA

switching distance	50mm	50mm
output signal	pnp, no	pnp, no
operating voltage	10 ... 35V DC	10 ... 35V DC
current consumption (w/o load)	≤ 15mA	≤ 15mA
output current (max. load)	150mA	150mA
voltage drop (max. load)	2.0V DC	2.0V DC
hysteresis	3 ... 15%	3 ... 15%
switching frequency	100Hz	100Hz
display (signal)	-	-
short-circuit protection	+	+
reverse polarity protection	+	+
dimensions	M80x1.5	M80x1.5
housing material	stainl. steel	stainl. steel
material (front cap)	Vectra®	Vectra®
length (thread/complete)	40mm / 66mm	40mm / 81mm
operating temperature	0 ... +160°C	0 ... +160°C
degree of protection (EN 60529)	IP65	IP50
connection	see above	Lemo connector
connection accessories	e.g. VK50H026	e.g. VK200940
mounting accessories	AY000101/AY000104	AY000101/AY000104

switching distance	2mm	4mm	25mm
operating temperature	0 ... +140°C	0 ... +130°C	0 ... +150°C
output signal	pnp, no	pnp, no	pnp, no
mounting	flush	flush	non-flush
2m silicone cable	IB090150	IB130155	-
5m silicone cable	IB090151	IB130156	-
M12-connector	-	-	IN40012W

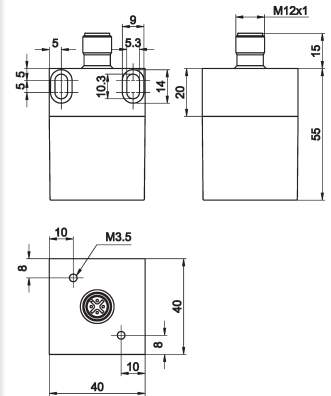
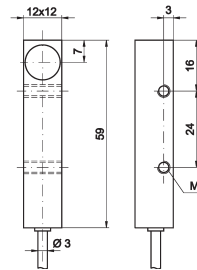
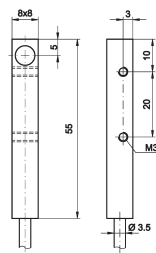

**TECHNICAL DATA**

switching distance	2mm	4mm	25mm
output signal	pnp, no	pnp, no	pnp, no
operating voltage	10 ... 30V DC	10 ... 30V DC	10 ... 35V DC
current consumption (w/o load)	≤ 15mA	≤ 15mA	≤ 15mA
output current (max. load)	50mA	200mA	200mA
voltage drop (max. load)	2.0V DC	2.0V DC	2.0V DC
hysteresis	3 ... 15%	3 ... 15%	3 ... 15%
switching frequency	600Hz	500Hz	200Hz
display (signal)	-	-	-
short-circuit protection	+	+	+
reverse polarity protection	+	+	+
dimensions	8x40x8mm	12x55x12mm	40x40mm
housing material	stainl. steel	stainl. steel	stainl. steel
material (front cap)	Vectra®	Vectra®	Vectra®
length (thread/complete)	- / 40mm	- / 55mm	- / 55mm
operating temperature	0 ... +140°C	0 ... +130°C	0 ... +150°C
degree of protection (EN 60529)	IP65	IP65	IP65
connection	see above	see above	M12-connector
connection accessories	-	-	e.g. VK50H026
mounting accessories	-	-	e.g. AY000135

switching distance	2mm	2mm	2mm	5mm
operating temperature	-25 ... +130°C	-25 ... +130°C	-25 ... +130°C	-25 ... +130°C
output signal	pnp, no	pnp, no	pnp, no	pnp, no
mounting	flush	flush	flush	flush
2m silicone cable	IC120155	-	-	IC180155
M12-connector	-	-	IC12012W	-
Lemo mini-connector	-	IC120110	-	-

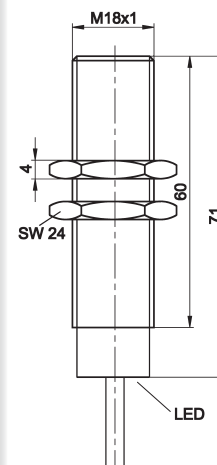
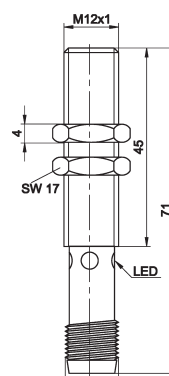
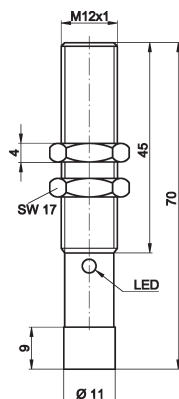
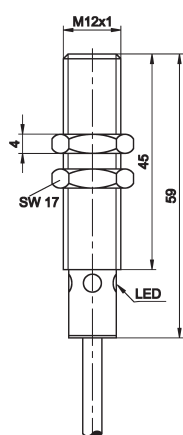

### TECHNICAL DATA

switching distance	2mm	2mm	2mm	5mm
output signal	pnp, no	pnp, no	pnp, no	pnp, no
operating voltage	7 ... 35V DC	7 ... 35V DC	7 ... 35V DC	7 ... 35V DC
current consumption (w/o load)	≤ 15mA	≤ 15mA	≤ 15mA	≤ 15mA
output current (max. load)	150mA	150mA	150mA	150mA
voltage drop (max. load)	2.0V DC	2.0V DC	2.0V DC	2.0V DC
hysteresis	3 ... 20%	3 ... 20%	3 ... 20%	3 ... 15%
switching frequency	40Hz	40Hz	40Hz	30Hz
display (signal)	yellow LED	yellow LED	yellow LED	yellow LED
short-circuit protection	+	+	+	+
reverse polarity protection	+	+	+	+
dimensions	M12x1	M12x1	M12x1	M18x1
housing material	stainl. steel	stainl. steel	stainl. steel	stainl. steel
material (front cap)	stainl. steel	stainl. steel	stainl. steel	stainl. steel
length (thread/complete)	45mm / 59mm	45mm / 70mm	45mm / 71mm	60mm / 71mm
operating temperature	-25 ... +130°C	-25 ... +130°C	-25 ... +130°C	-25 ... +130°C
degree of protection (EN 60529)	IP65	IP50	IP65	IP65
connection	2m silicone cable	Lemo mini-connector	M12-connector	2m silicone cable
connection accessories	-	e.g. VK2000L4	e.g. VK50H026	-
mounting accessories	AY000099	AY000099	AY000099	AY000100

switching distance	5mm	10mm	10mm	2mm
operating temperature	-25 ... +130°C	-25 ... +130°C	-25 ... +130°C	-25 ... +130°C
output signal	pnp, no	pnp, no	pnp, no	pnp, no
mounting	flush	flush	flush	flush
2m silicone cable	-	IC300155	-	-
Lemo connector	IC180145	-	IC300145	-
Lemo mini-connector	-	-	-	IC130110

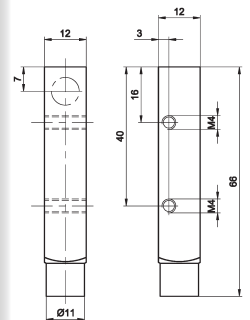
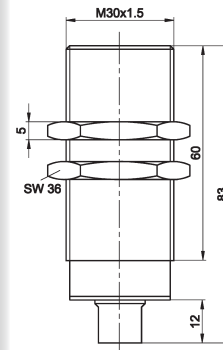
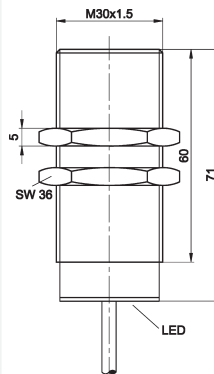
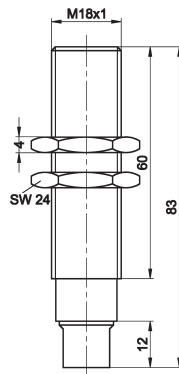

**TECHNICAL DATA**

switching distance	5mm	10mm	10mm	2mm
output signal	pnp, no	pnp, no	pnp, no	pnp, no
operating voltage	7 ... 35V DC	7 ... 35V DC	7 ... 35V DC	10 ... 30V DC
current consumption (w/o load)	≤ 15mA	≤ 15mA	≤ 15mA	≤ 15mA
output current (max. load)	150mA	150mA	150mA	200mA
voltage drop (max. load)	2.0V DC	2.0V DC	2.0V DC	2.0V DC
hysteresis	3 ... 15%	3 ... 15%	3 ... 15%	3 ... 15%
switching frequency	30Hz	30Hz	30Hz	40Hz
display (signal)	-	yellow LED	-	-
short-circuit protection	+	+	+	+
reverse polarity protection	+	+	+	+
dimensions	M18x1	M30x1.5	M30x1.5	12x66x12mm
housing material	stainl. steel	stainl. steel	stainl. steel	stainl. steel
material (front cap)	stainl. steel	stainl. steel	stainl. steel	stainl. steel
length (thread/complete)	60mm / 83mm	60mm / 71mm	60mm / 83mm	- / 66mm
operating temperature	-25 ... +130°C	-25 ... +130°C	-25 ... +130°C	-25 ... +130°C
degree of protection (EN 60529)	IP50	IP65	IP50	IP50
connection	Lemo connector	2m silicone cable	Lemo connector	Lemo mini-connector
connection accessories	e.g. VK200940	-	e.g. VK200940	e.g. VK2000L4
mounting accessories	AY000100	AY000101/AY000104	AY000101/AY000104	-

cable socket	M12 cable socket +150°C angular	M12 cable socket +150°C straight	M12 cable socket +150°C straight	M12 cable connector +150°C straight
number of pins (assigned)	3-wire	3-wire	4-pin	4-pin
article-no.	VK50H022 polyolefin	VK50H026 polyolefin	VK003524	VK003528
length	5m	5m	field attachable	field attachable
article-no.	VKA0H022 polyolefin	VKA0H026 polyolefin	-	-
length	10m	10m	-	-

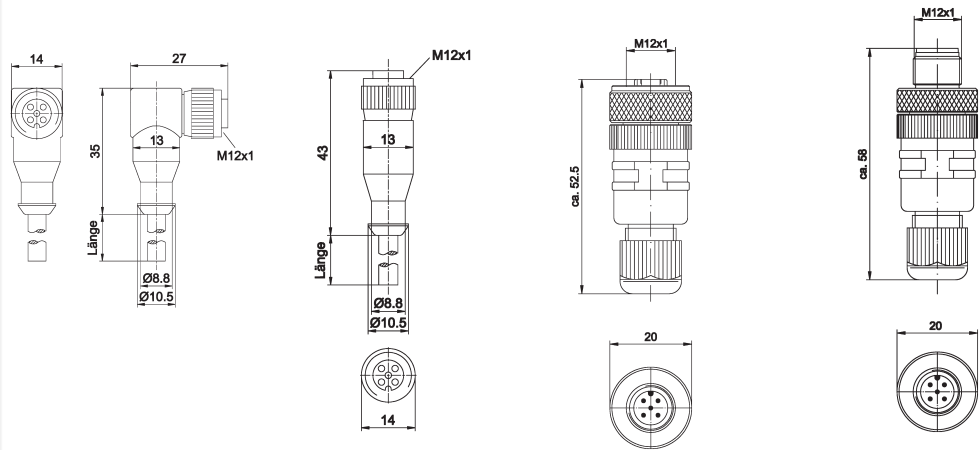

cable socket	Lemosa mini, angular	Lemosa mini, straight	Lemosa, straight
number of pins (assigned)	3-wire	3-wire	3-wire
article-no.	VK2000L0, silicone	VK2000L4, silicone	VK200940, silicone
length	2m	2m	2m
article-no.	VK5000L0, silicone	VK5000L4, silicone	VK500940, silicone
length	5m	5m	5m
article-no.	VKA000L0, silicone	VKA000L4, silicone	VKA00940, silicone
length	10m	10m	10m
article-no.	VK2000L1, teflon	VK2000L5, teflon	VK200941, teflon
length	2m	2m	2m
article-no.	VK5000L1, teflon	VK5000L5, teflon	VK500941, teflon
length	5m	5m	5m
article-no.	VKA000L1, teflon	VKA000L5, teflon	VKA00941, teflon
length	10m	10m	10m
article-no.	-	-	VKB00941, teflon
length	-	-	20m

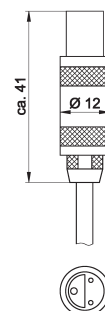
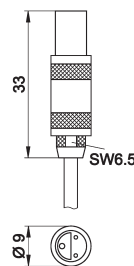
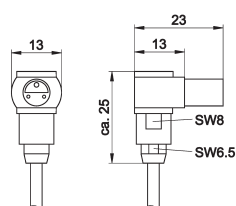

**connection**

PNP, no

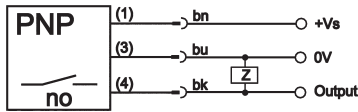

wire colors: bn = brown (1), bu = blue (3), bk = black (4)

NPN, no

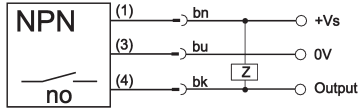

wire colors: bn = brown (1), bu = blue (3), bk = black (4)

PNP, nc

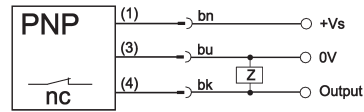

**mounting material**

**AY000098** for design M8x1, stainl. steel

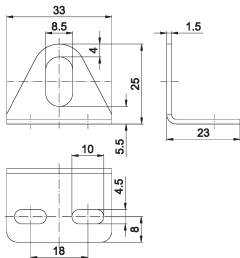

**AY000099** for design M12x1, stainl. steel

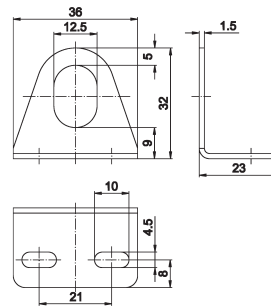

**AY000100** for design M18x1, stainl. steel

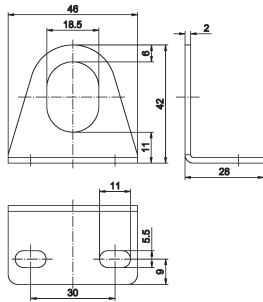

**AY000101** for design M30x1.5, stainl. steel

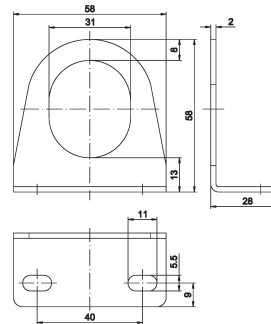

**AY000104** for design M30x1.5, aluminum

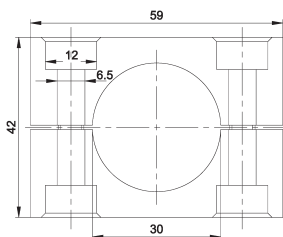

**AY000135** for design 40

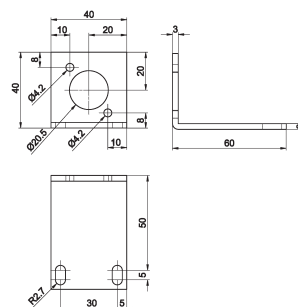

This data sheet contains only the available standard versions. Please contact us for other output and connection versions.

We will be pleased to supply the matching cable socket for your connector devices. Please refer to the list in catalog chapter "accessories" under "cable sockets **ipf-SENSORFLEX**®" or search our website for "VK".

**Warning:** Never use these devices in applications where the safety of a person depends on their functionality.

---

**NOTES**

A large grid area for taking notes, consisting of a 20x20 grid of small squares. The grid is empty and occupies the majority of the page below the 'NOTES' header.